

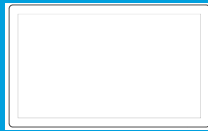

GLORystAR

## **21.5 - 32inch Mobile Metal Floor Stand**



Large-Screen Display

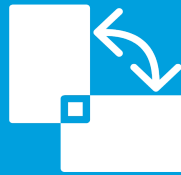

Support Landscape/Portrait



VESA

### Overview







The floor-standing self-service kiosk stand is designed for commercial, public, and industrial applications and accommodates displays ranging from 21.5 to 32 inches. It supports both landscape and portrait orientation rotation and is compatible with VESA mounting hole patterns of 100×100 mm. The height is adjustable by 130 mm. The stand offers two configuration options: with or without a built-in battery. Equipped with omnidirectional casters enabling 360° movement, it facilitates flexible deployment across diverse environments. The main frame is constructed from SPCC steel and aluminum alloy, ensuring robustness and durability, with a maximum load capacity of 9 kg to guarantee long-term safe and reliable operation of large displays.

## Specifications

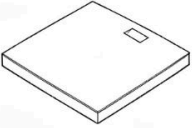
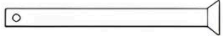
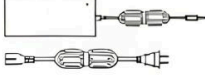
	Mobile Metal Floor Stand	
Model	FIX-046	FIX-047
Type	Without battery	With battery
Base Shape	Square base	
Compatibility	21.5 - 32 inch display	
Column Material	Aluminum alloy	
Base Material	SPCC	
Color	Deep Space Gray or White (Available in two colors )	
Field of View	Pitch Adjustment of 20°	
Swivel Range	0°~+90°	
Height	1192mm	
Lift and lower	130 mm vertical height adjustment	
Max Load Capacity	9Kg	
VESA mounting holes	100 x 100 Aperture: 4.2mm	
Battery Capacity	None	Two battery capacity options are available 133 Wh (9000 mAh) or 220 Wh (15000 mAh)
Charger	None	16.8V 3A 50.4W
Power Switch	Illuminated metal button	
Mobility	Yes, With Caster Wheels Braking is not Supported	
Weight	8.9Kg	9.8Kg
Inner Box Size (LxWxH)	695 x 497 x 151 mm	
Outer Box Size (LxWxH)	Same size as the inner box	
Gross Weight	10.7kg	11.6kg
Pieces / Carton	1pc / ctn	

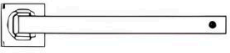
Note: If the battery is not included, the charger and cables will not be provided.

## Accessories

① Base 	③ Lower Column 	⑤ Charger 	⑦ M6*8 Screws*4 	⑨ Power Cord 
② Upper Column 	④ Screwdriver 	⑥ BM4*10 Screws*4 	⑧ M8 Connecting Screw*1 	

# Dimension

## Square Base

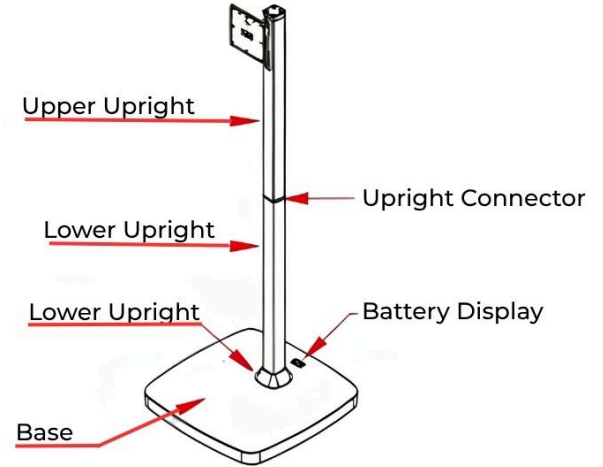
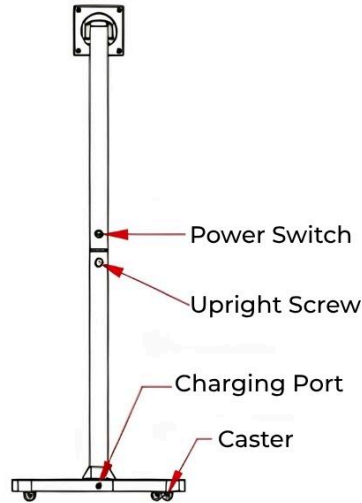
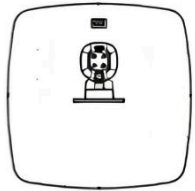
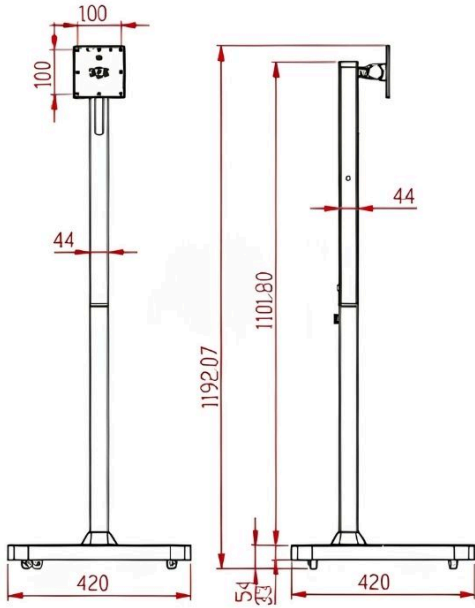

## CONTACT US

### United States

1440 N. Harbor Blvd Suite 900  
Fullerton, CA 92835, USA  
626 228 5927

### Hong Kong

Flat D, 5/F, Excelsior Building,  
364 Nathan Road,  
Kowloon, Hong Kong  
852 23762803

### ShenZhen

Bldg. 9, 4/F Zhong Yuntai Technology Industrial  
Park, Tangtou No.1 Road, Shiyan Street, Baoan,  
ShenZhen, PRC  
86 755 2600 1808

To find out more about our extensive range of Glory Star solutions, go to [www.glorystargroup.com](http://www.glorystargroup.com), or call the office nearest you. For more information, please contact us at [sales@glorystargroup.com](mailto:sales@glorystargroup.com). Glory Star reserves the right to change or update, without notice, any information contained herein; to change, without notice, the design, construction, materials, processing or specifications of any products; and to discontinue or limit production or distribution of any products. Glory Star, the Glory Star logo, STAR CONTROL and STAROS are either trademarks or registered trademarks of Glory Star Group Limited. All other trademarks are the property of their respective owners.